

Instruction Manual

Valid as of: 01.04.2025 • Please keep the manual for future reference!



Checkline Europe S.L. ®
Calle Real 85, Planta 2 B1
29680 Estepona (Málaga)
España

Tel: +34 951 870 125
Web: <https://www.checkline.es>
E-mail: info@checkline.es



Contents

1 Warranty and liability	3
1.1 Notices within the instruction manual	3
1.2 Responsibilities of the operating company	3
1.3 Responsibilities of the personnel	3
1.4 Informal safety measures	4
1.5 Training of the personnel	4
1.6 Intended use	4
1.7 Dangers in handling the device	4
1.8 Copyright	4
1.9 Declaration of conformity, RoHs II and WEEE registration	4
2 Specifications	5
2.1 Delivery includes	5
2.2 Unpacking and assembly	5
3 Initial setup and operating procedure	6
3.1 Notices before starting measurement	6
3.2 Operating elements	6
3.2.1 Display details	7
3.2.2 Aligning the instrument	7
3.3 Connecting the AC adapter	7
3.3.1 Switch-on	7
3.3.2 Switch-off	7
3.4 Settings	8
3.4.1 Adjusting the operation mode	8
3.4.2 Weighing with the English cotton count system Ne	8
3.4.3 Zero Setting (zero)	9
3.5 Measuring procedure	9
3.6 Calibration of the instrument	10
4 Service and maintenance	11
5 Cleaning	11
6 Correspondence	11
7 Repairs	11

1 Warranty and liability

In principle, the supply of the device is subject to our “General Conditions of Sale and Delivery.” These have been provided to the operating company on conclusion of the contract, at the latest.

Warranty:

- SCHMIDT area weight balances are warranted for 12 months.
- Parts subject to wear, electronic components and measuring springs are not covered by the warranty. No warranty or liability will be accepted for bodily injury or property damage resulting from one or several of the following causes:
 - Misuse or abuse of the device.
 - Improper mounting, commissioning, operation and maintenance of the device (e.g. verification interval).
 - Operation of the device if any safeguards are defective or if any safety and protection precautions are not properly installed or not operative.
 - Failure to comply with the notices in the instruction manual regarding transport, storage, mounting, commissioning, operation, maintenance and setup of the device.
 - Any unauthorized structural alteration of the device.
 - Insufficient inspection of device components that are subject to wear.
 - Opening the device or improper repair work.
 - Disasters caused by the effects of foreign objects or by force majeure.

1.1 Notices within the instruction manual

The fundamental prerequisite for the safe handling of this device and its troublefree operation is the knowledge of the basic safety notices and safety instructions.

These instruction manual contains the most important notices for the safe operation of the device.

These instruction manual, in particular the safety notices, must be observed by any person who works with the device. In addition, the local valid rules and regulations for the prevention of accidents must be complied with.

The representations within the instruction manual are not true to scale.

The dimensions given are not binding.

General indications of direction, such as FRONT, REAR, RIGHT, LEFT apply when viewing the front of the device.

1.2 Responsibilities of the operating company

In compliance with the EC Directive 89/655/EEC, the operating company agrees to only permit persons to work with the device who:

- are familiar with the basic regulations on industrial safety and accident prevention and who have been trained in handling the device.
- have read and understood the chapter on safety and the warning notices in these instruction manual and have confirmed this with their signatures.
- are examined regularly on their safe and conscientious working method.

1.3 Responsibilities of the personnel

All persons who work with the device agree to perform the following duties before starting work:

- to observe the basic regulations on industrial safety and accident prevention.
- to read the chapter on safety and the warning notices in these instruction manual and to confirm with their signatures that they have understood them.

1.4 Informal safety measures

The instruction manual must always be kept on hand where the device is operated. Apart from the instruction manual, the general and local valid regulations on accident prevention and environmental protection must be provided and complied with.

1.5 Training of the personnel

Only trained and instructed personnel is permitted to work with the device. The responsibilities of the personnel must be clearly defined for mounting, commissioning, operation, setup, maintenance, and repair. Trainees may only work with the device under the supervision of experienced personnel.

1.6 Intended use

The device is intended exclusively to be used as a balance. Any other use or any use exceeding this intention will be regarded as misuse. Under no circumstances shall Hans Schmidt & Co GmbH be held liable for damage resulting from misuse.

The intended use also includes:

- Complying with all notices included in the instruction manual and observing all inspection and maintenance works.

1.7 Dangers in handling the device

The device was designed according to the state of the art and the approved safety standards. Nevertheless, its use may cause serious or fatal injury to the user or third persons, and/or an impairment of the device or of other material assets.

The device may only be applied:

- For its intended use in a faultless condition with regard to the safety requirements.
- Malfunctions that could impair safety must be remedied immediately.
- Personal protective equipment must be used according to the EC Directive 89/686/EEC.



The device must not be operated in potential explosive areas and must not come into contact with aggressive substances.

1.8 Copyright

The copyright on these instruction manual remains with the company Hans Schmidt & Co GmbH.

These instruction manual is intended for the operating company and its personnel only. They contain instructions and notices that may only be reproduced on the prior written permission of Hans Schmidt & Co GmbH and under indication of the complete reference data. Violations will be prosecuted.

1.9 Declaration of conformity, RoHs II and WEEE registration

In compliance with the EU Directives 2014/30/EU and 2011/65/EU

Distributed by:



Checkline Europe S.L. ®
Calle Real 85, Planta 2 B1
29680 Estepona (Málaga)
España

Tel: +34 951 870 125
Web: <https://www.checkline.es>
E-mail: info@checkline.es

2 Specifications

Capacity:	Weight mode: 300 g Area weight mode: 30 000 g/m ²
Sample size:	Area weight mode: 100 cm ² Yarn counting system: 100 m
Resolution:	Weight mode: 0.01 g respectively 0.001 oz Area weight mode: 1g/m ² respectively 0.1 oz/yd ² Direct yarn counting system: 0.1 Tex respectively 0.1 Denier Indirect yarn counting system: 0.1 Nm respectively 0.1 Ne
Platform size:	Ø 130 mm
Power supply:	AC adapter 100 - 240 V AC - 50/60 Hz or 3 x AA Mignon
Temperature range:	0 - 40° C
Air humidity:	85% RH, max.
Weight net (gross):	Approx. 1.0 kg (2.0 kg)
Dimensions:	270 x 195 x 65 mm (L x W x H)

2.1 Delivery includes

- Balance
- AC adapter
- Calibration weight 200 g
- Wind shield
- Instruction manual

2.2 Unpacking and assembly

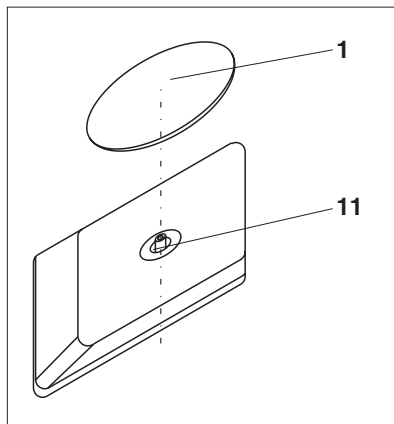

- Unpack the WYB-300.
- Inspect the WYB-300 for any shipping damage. Should you find any damage, immediately notify the vendor. Notices of defect must be filed immediately, in writing, at the latest within 7 days on receipt of the goods.

Assembly:

- Carefully press the sample platform **1** onto the weighing shaft **11**.

Removal:

- Remove the support plate **1** from the weighing shaft **11**.



The support plate must be removed for transport to avoid damage of the balance.

3 Initial setup and operating procedure

3.1 Notices before starting measurement



Have you read and understood the instruction manual, in particular chapter 1 “Warranty and liability”? You are not permitted to operate the device before doing so. Before working with the device you must put on your personal protective clothing, if necessary. For example, eye protectors, gloves, etc. The ID plate with the serial number and the CE mark is provided on the left side of the instrument.

3.2 Operating elements

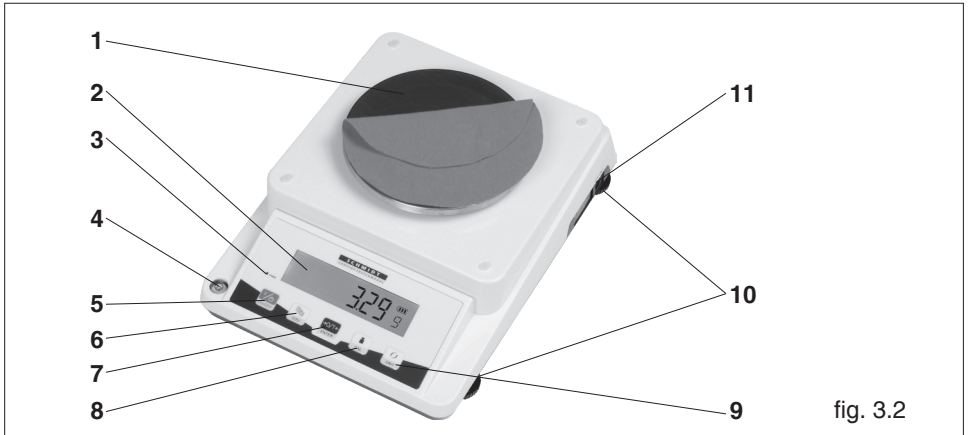
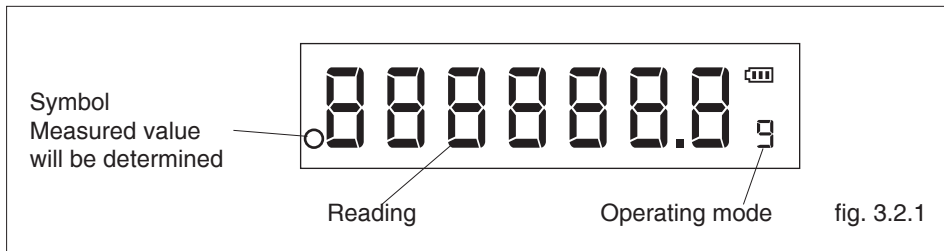

fig. 3.2

1	Platform	Sample measuring plate
2	Display	Chapter 3.2.1
3	LED Power	Lights up when the scale is connected to the power supply via the AC adapter.
4	Bubbel level	For horizontal alignment of the balance
5	ON/Off key	Switches the balance on and off
6	COU key	For adjusting the material mixture for measurements according to the Ne system
7	Enter key	For zero setting of the balance
8	CAL key	For calibrating the balance
9	Mode key	Switch between g, g/m ² , oz, oz/yd ² , Tex, Nm, Ne and Denier.
10	Base feet	4 adjustable feet at the bottom of the instrument
10	Connector	For connecting the AC adapter

3.2.1 Display details



3.2.2 Aligning the instrument

Before switching on the instrument, the balance must be set up in such a way that it is exactly horizontal.

This means: The air bubble of the level must be precisely in the middle of the marking.

The instrument is provided with four setscrews on the bottom for horizontal alignment.

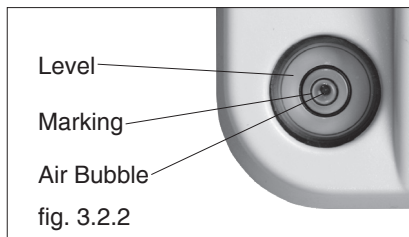

3.3 Connecting the AC adapter

The instrument is supplied without batteries. It can be operated with the supplied AC adapter, but also with rechargeable batteries or batteries (AA).

i Before connecting the AC adapter, check the supply voltage. Claims for warranty or liability will not be accepted for AC adapters from other manufacturers. If the balance is connected to the power supply via the AC adapter, the Power LED lights up.

To connect the AC adapter:

- Plug in the AC adapter cable at the power connector.

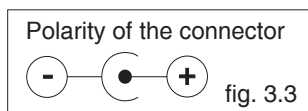

3.3.1 Switch-on

Requirements:

- The AC adapter is connected.
- Press the  button.

The display briefly shows in succession , the measuring range  and .

Once complete, the zero point is set automatically (auto zero) and the balance displays  and is ready for operation.

3.3.2 Switch-off

- Press the  button.

3.4 Settings

3.4.1 Adjusting the operation mode

By pressing the  button, switching between the operating modes grams (g), ounces (OZ), Tex (TEX), Nm (NM), Ne (NE), Denier (D), grams per square meter (GM') and ounces per square yard (OY').

3.4.2 Weighing with the English cotton count system Ne

Requirements:

The Ne operating mode must be selected according to chapter 3.4.1.



Before weighing with the English cotton count system Ne, the required material mixture must be set.

Therefore the button  must be pressed. The display shows .

The different material mixtures are now switched through automatically.

When the desired material is displayed, press the  button to select it.

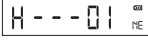
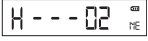
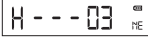
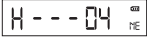
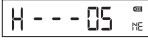
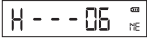
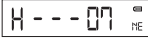
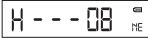
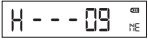
The following material mixtures are available:

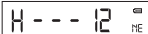
	cotton
	50 % polyester / 50 % cotton
	65 % polyester / 35 % cotton
	55 % polyester / 45 % cotton
	45 % polyester / 55 % cotton
	35 % polyester / 65 % cotton
	65 % polyester / 35 % Nitrilon
	50 % cotton / 50 % polypropylene fiber
	50 % cotton / 50 % nitrilon
	65 % polyester / 35 % viscose fiber
	55 % polyester / 45 % viscose fiber
	50 % cotton / 50 % viscose fiber



When switching off, the material mix last set is not saved.

3.4.3 Zero Setting (zero)

If the balance shows a measured value without a load, the zero setting must be conducted.

To carry out zero setting:

- Press the  button.
The display now shows the value zero.

3.5 Measuring procedure

Requirements:

- The Instrument is switched on as described in chapter 3.3.1.
The Function settings are selected as described in chapters 3.4.1 and 3.4.2.
- Zero setting (auto zero) carried out as described in chapter 3.4.3.

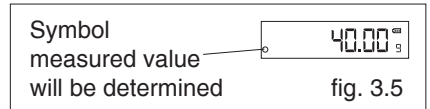

To measure the process material:

- Place the sample to be measured on the platform.



The measurement result on the display is only correct when the "measured value will be determined" symbol is no longer shown.

3.6 Calibration of the instrument

The balance is supplied with a 200 g calibration weight for recalibrating the instrument on site or checking the measurement accuracy.









Requirement:

The Instrument is switched on as described in chapter 3.3.1.

The operation mode “g” is adjusted

There is no sample on the platform.

To calibrate the instrument:

- Press the  button.
The display shows  .
- Press and hold the  button until  is shown on the display.
- If  flashes in the display, the calibration weight must be placed on the support plate.
- The display briefly shows  and then .
- Then remove the weight from the platform. The display briefly shows  and then .

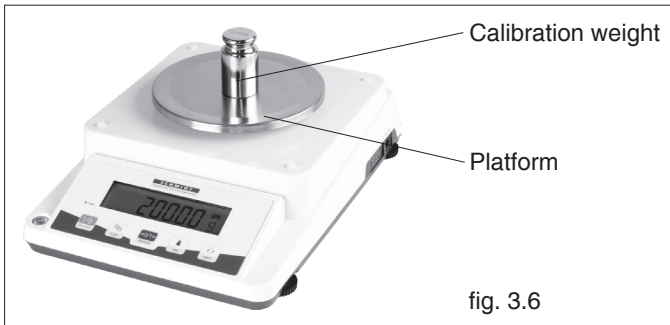

**Do not subject the instrument to shock or vibration during calibration.
Press the keys gently and not too quickly in succession.**

4 Service and maintenance

The instrument is easy to maintain. Depending on operating time and load, the instrument should be checked according to the locally valid regulations and conditions (as described in chapter 3.6). The use of other test methods than the procedure described in chapter 3.6 may cause deviating measuring results.

5 Cleaning

For cleaning the unit, do not use any



AGGRESSIVE SOLVENTS

such as trichloroethylene or similar chemicals.



NO WARRANTY OR LIABILITY

shall be accepted for damage resulting from improper cleaning.

6 Correspondence

Should you have any questions regarding the instrument or instruction manual, or their use, please indicate above all the following details which are given on the ID plate:

- 1.) Model
- 2.) Serial number

7 Repairs

Shipping instructions:

We kindly ask for return free of charge for us, if possible by airmail parcel. All occurring charges, if any (such as freight, customs clearance, duty etc.), will be billed to customer. For return from foreign countries, we ask you to include a proforma invoice with a low value for customs clearance only, e.g. 10 Euro, each and to advise the shipment in advance by fax or eMail.



To avoid unnecessary follow-up questions, and the resulting loss of time or possible misunderstandings, please return the instrument with a detailed fault description to our service department.

Distributed by:



Checkline Europe S.L. ®
Calle Real 85, Planta 2 B1
29680 Estepona (Málaga)
España

Tel: +34 951 870 125
Web: <https://www.checkline.es>
E-mail: info@checkline.es



Checkline Europe S.L. ®
Calle Real 85, Planta 2 B1
29680 Estepona (Málaga)
España

Tel: +34 951 870 125
Web: <https://www.checkline.es>
E-mail: info@checkline.es